

Please note that the data given here has been taken from the online catalog. For comprehensive information and data, please refer to the user documentation at <http://www.download.phoenixcontact.com>. The General Terms and Conditions of Use apply to Internet downloads.

▶ Extract from the online catalog

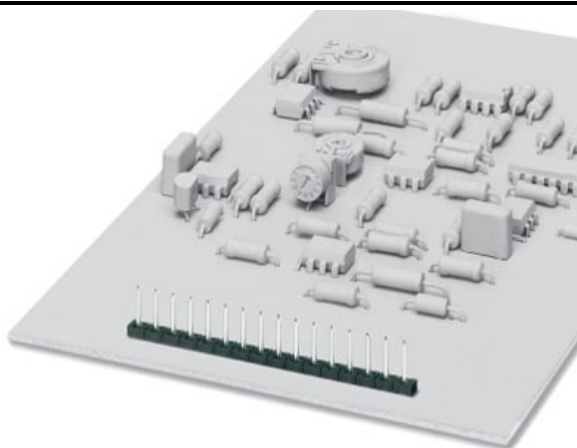

Male connector, 3.5 mm pitch, for use with mini printed circuit terminal blocks FK-MPT 05/...-ST-3.5, color: black

The illustration shows a combination as a 16-position version

Order No.	1945106
Ord designation	PST 1,0/ 3-3,5
EAN	4017918883270
Pack	50 Pcs.
Customs tariff	85369010
Catalog page information	Page 312 (CC-2005)

▶ Technical data

Dimensions / positions

Pitch	3.5 mm
Dimension a	7 mm
Number of positions	3
Pin dimensions	1 mm
Hole diameter	1.1 mm

Technical data

Insulating material group	IIIa
Rated surge voltage (III/3)	2.5 kV
Rated surge voltage (III/2)	2.5 kV
Rated surge voltage (II/2)	2.5 kV
Rated voltage (III/2)	250 V
Rated voltage (II/2)	250 V
Maximum load current	6 A (Depends on the plug used)
Insulating material	PA
Inflammability class acc. to UL 94	V0

► Drawings

Drilling diagram

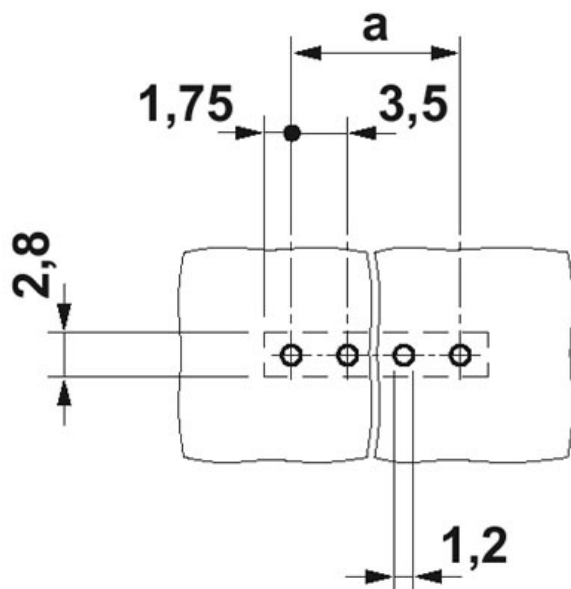

Dimensioned drawing

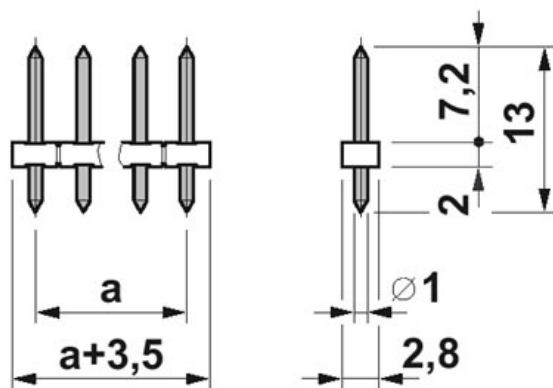

► Address

PHOENIX CONTACT GmbH & Co. KG
Flachsmarktstr. 8
32825 Blomberg
Germany
Phone +49 5235 3 00
Fax +49 5235 3 1200
<http://www.phoenixcontact.com>
Phoenix Contact
Technical modifications reserved;